

# DH-SD22204-GC-LB

2MP 4x Starlight HDCVI PTZ Camera



- 1/2.8" 2Megapixel STARVIS™ CMOS
- Powerful 4x optical zoom
- Starlight technology
- 120 dB true WDR, 3D DNR
- Max. 25/30 fps@1080P, 25/30/50/60 fps@720P
- IP66, IK10



## System Overview

Featuring with powerful optical zoom and accurate pan/tilt/zoom performance, the SD22 series PTZ camera can provide large monitoring range and great detail. The camera delivers 1080P resolution at 25/30 fps, with 4x optical zoom, and has very excellent low light performance due to the latest starlight technology. SD22 series PTZ camera is equipped with smooth control, high quality image and good protection, which makes it meet small and medium-sized video surveillance applications.

## Functions

### Simplicity

HDCVI technology inherits the born feature of simplicity from traditional analog surveillance system, making itself an ideal choice for investment protection. HDCVI system can seamlessly upgrade the traditional analog system without replacing existing coaxial cabling. The plug and play approach enables full HD video surveillance without the hassle of configuring network.

### Starlight Technology

For challenging low-light applications, Dahua's Starlight Ultra-low Light Technology offers best-in-class light sensitivity, capturing color details in low light down to 0.005 lux. The camera uses a set of optical features to balance light throughout the scene, resulting in clear images in dark environments.

## Environmental

The camera is designed for extreme temperature environments. Subjected and certified to rigorous dust and water immersion tests, the IP66 rating makes it suitable for demanding outdoor applications.

## Wide Dynamic Range

The camera achieves vivid images, even in the most intense contrast lighting conditions, using industry-leading wide dynamic range (WDR) technology. For applications with both bright and low lighting conditions that change quickly, True WDR (120 dB) optimizes both the bright and dark areas of a scene at the same time to provide usable video.

## Technical Specification

### Camera

Image Sensor	1/2.8" STARVIS™ CMOS
Pixel	2MP
Max. Resolution	1920 (H) x 1080 (V)
ROM	16 MB
RAM	256 MB
Electronic Shutter Speed	1/3 s–1/100000 s
Scanning System	Progressive
Min. Illumination	Color: 0.05 Lux@F1.6 B/W: 0.005 Lux@F1.6

### Lens

Focal Length	2.7 mm–11 mm			
Max. Aperture	F1.6–F2.7			
Field of View	H: 112.5°–30°; V: 54.2°–19.9°; D: 122.3°–40.6°			
Optical Zoom	4x			
Focus Control	Auto/Semi-Auto/Manual			
Close Focus Distance	0.5 m–1 m (1.64 ft–3.28 ft)			
Iris Control	Fixed			
DORI Distance	Detect	Observe	Recognize	Identify
	120 m (393.70 ft)	48 m (157.48 ft)	24 m (78.74 ft)	12 m (39.37 ft)

### PTZ

Pan/Tilt Range	Pan: 0°–355° Tilt: 0°–90°
Manual Control Speed	Pan: 0.1°–100°/s Tilt: 0.1°–60°/s
Preset Speed	Pan: 100°/s; Tilt: 60°/s
Preset	300
Tour	8 (up to 32 presets per tour)
Speed Adjustment	Support
Power-off Memory	Support
Idle Motion	Preset/Tour
Protocol	DH-SD Pelco-P/D (auto recognition)

### Video

Resolution	1080P (1920 × 1080); 720P (1280 × 720); D1 (704 × 576/704 × 480)
Frame Rate	1080P (25/30 fps); 720P (25/30/50/60 fps)
CVI Product Output Mode	CVI; TVI; AHD; CVBS
Day/Night	Support

BLC	Support
WDR	120 dB
HLC	Support
White Balance	Auto/Indoor/Outdoor/Tracking/Manual/Sodium lamp/Natural/Street lamp
Gain Control	Auto/Manual
Noise Reduction	2D/3D
Defog	Electronic
Digital Zoom	16x
Flip	0°/180°

### Certification

Certifications	CE: EN55032/EN55024/EN50130-4 FCC: Part15 subpartB, ANSI C63.4-2014 UL: UL60950-1+CAN/CSA C22.2, No.60950-1
----------------	-------------------------------------------------------------------------------------------------------------------

### Port

Analog Output	1 (CVBS/CVI output, BNC port)
RS485	1 (baud rate range: 1200 bps–9600 bps)

### Power

Power Supply	12V DC/1.5A±10%
Power Consumption	5W 6W (PTZ on)

### Environment





Operating Temperature	-30°C to +60°C (-22°F to +140°F)
Operating Humidity	≤ 95%RH
Protection	IP66; IK10; TVS 4000V lightning proof; surge protection; voltage transient protection

### Structure

Casing	Metal
Dimensions	Φ122 mm × 89 mm (4.80" × 3.50")
Net Weight	0.6 kg (1.32 lb)
Gross Weight	0.65 kg (1.43 lb)

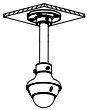
## Ordering Information

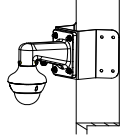
Type	Model	Description
2M Camera	DH-SD22204-GC-LB	2MP 4x Starlight HDCVI PTZ Camera, WDR, PAL
	DH-SD22204N-GC-LB	2MP 4x Starlight HDCVI PTZ Camera, WDR, NTSC
	SD22204-GC-LB	2MP 4x Starlight HDCVI PTZ Camera, WDR, PAL
	SD22204N-GC-LB	2MP 4x Starlight HDCVI PTZ Camera, WDR, NTSC
Accessories	DC12V/1.5A	Power Adapter
	PFA106	Mount Adapter
	PFA151	Corner Mount Bracket
	PFA120	Junction Box
	PFB305W	Wall Mount Bracket
	PFB203W	Wall Mount Bracket
	PFB220C	Ceiling Mount Bracket
	PFA150	Pole Mount Bracket
PFA152-E	Pole Mount Bracket	

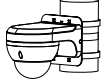
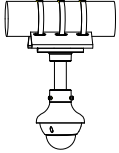
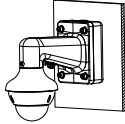
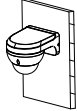
Ceiling Mount	Ceiling Mount	Corner Mount
PFA106+PFB220C		PFA106+PFB305W+PFA151
		
Pole Mount(Vertical)	Pole Mount(Vertical)	Pole Mount(Horizontal)
PFA106+PFB305W+PFA150	PFB203W+PFA152-E	PFA106+PFB220C+PFA150
		
Wall Mount	Wall Mount	
PFA106+PFB305W+PFA120	PFB203W	
		

## Dimensions (mm[inch])

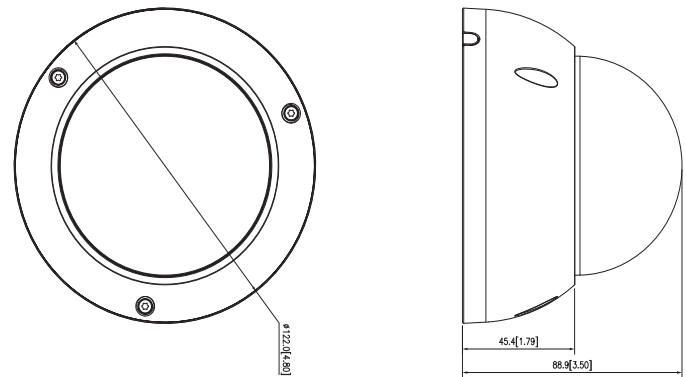

## Accessories

### Optional:



DC12V/1.5A  
Power Adapter



PFA106  
Mount Adapter

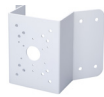

PFA151  
Corner Mount Bracket



PFA120  
Junction Box



PFB305W  
Wall Mount Bracket



PFB203W  
Wall Mount Bracket



PFB220C  
Ceiling Mount Bracket



PFA150  
Pole Mount Bracket



PFA152-E  
Pole Mount Bracket